



HIRAMOTO-M.KOBAYASHI LAB.



Silicon-Based Integrated Devices

Department of Informatics and Electronics

Integrated Device Engineering – Integrated Nanoelectronics

Department of Electrical Engineering and Information Systems, Graduate School of Engineering

<http://vlsi.iis.u-tokyo.ac.jp>
<https://nano-lsi.iis.u-tokyo.ac.jp>

Semiconductors: for Further Developments

Semiconductor VLSI (very large scale integration) is the basis of contemporary advanced IT society. Hiramoto/Kobayashi Lab. aims at solving worldwide problems by the technological innovation of future integrated nanoelectronics from the device side. Based on the vision in Fig. A, we are pursuing the extreme form of integrated nanodevices. For Japan's semiconductor industry restoration, Prof. Hiramoto joined Leading-edge Semiconductor Technology Center (LSTC) and Prof. Kobayashi participated in Rapidus Corporation.

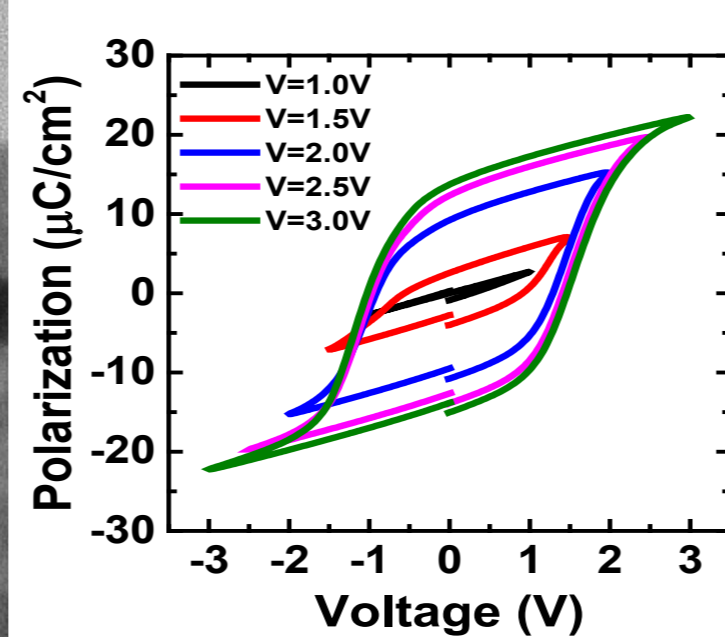
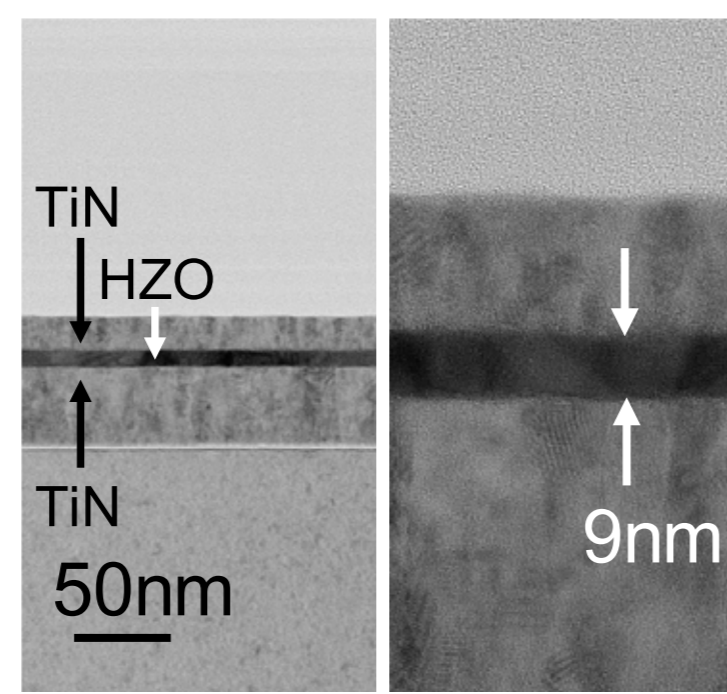
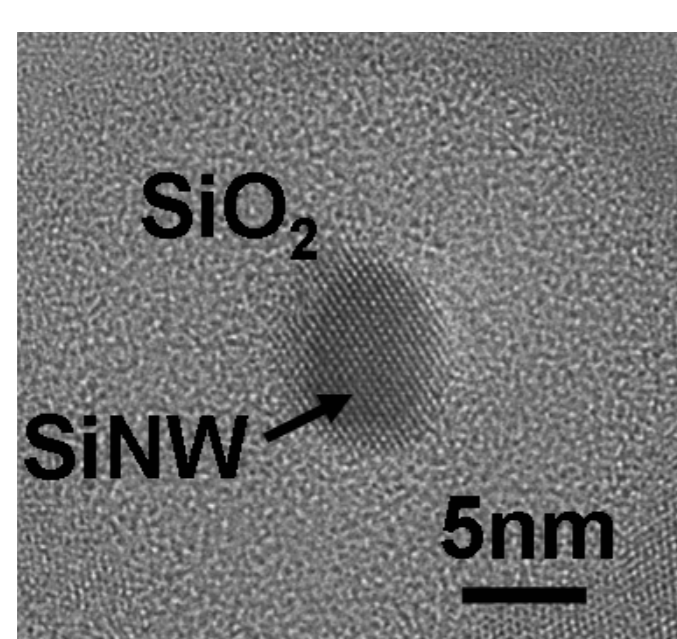

Fig. 3. CMOS-compatible ferroelectric nano film is an enabler for ultralow power logic and memory technology.

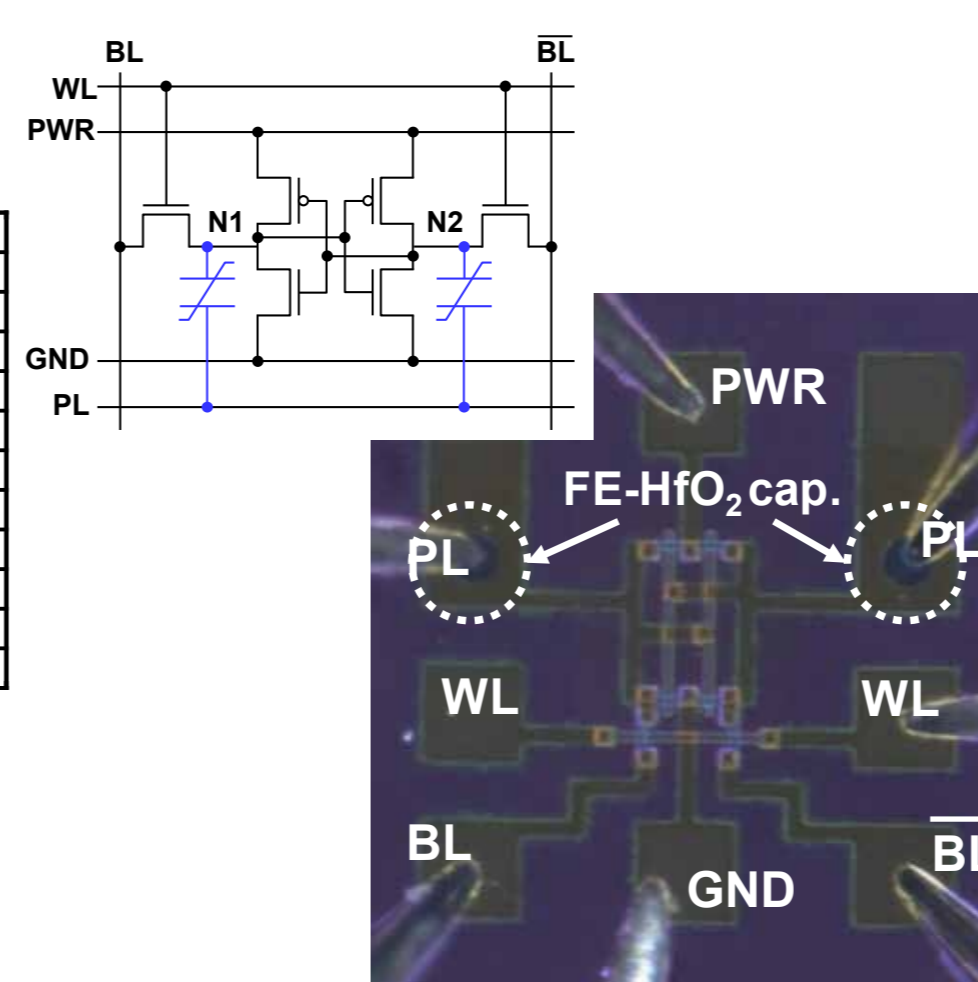

Fig. 4. Nonvolatile SRAM for smart power management.

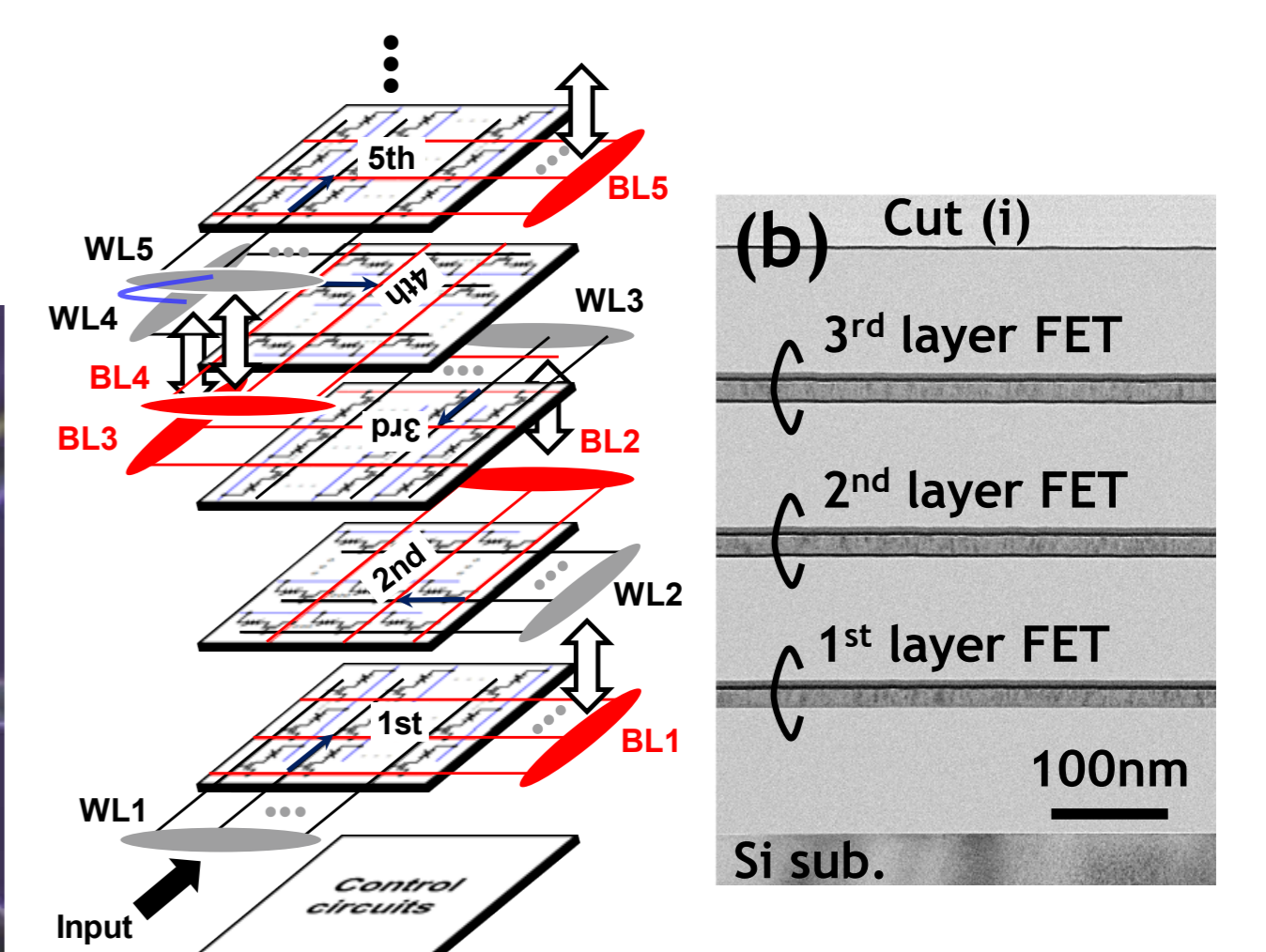

Fig. 5. 3D integration technology by oxide semiconductor IGZO transistor for AI hardware.

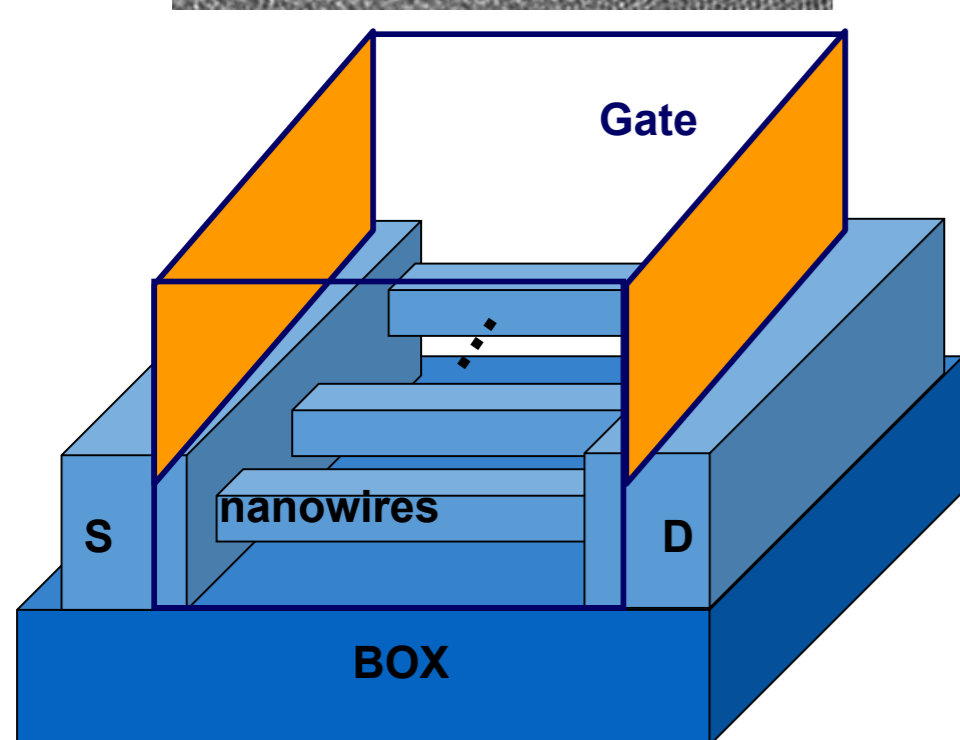

Fig. 1. Silicon nano-wire transistors were fabricated and the quantum effects were evaluated.

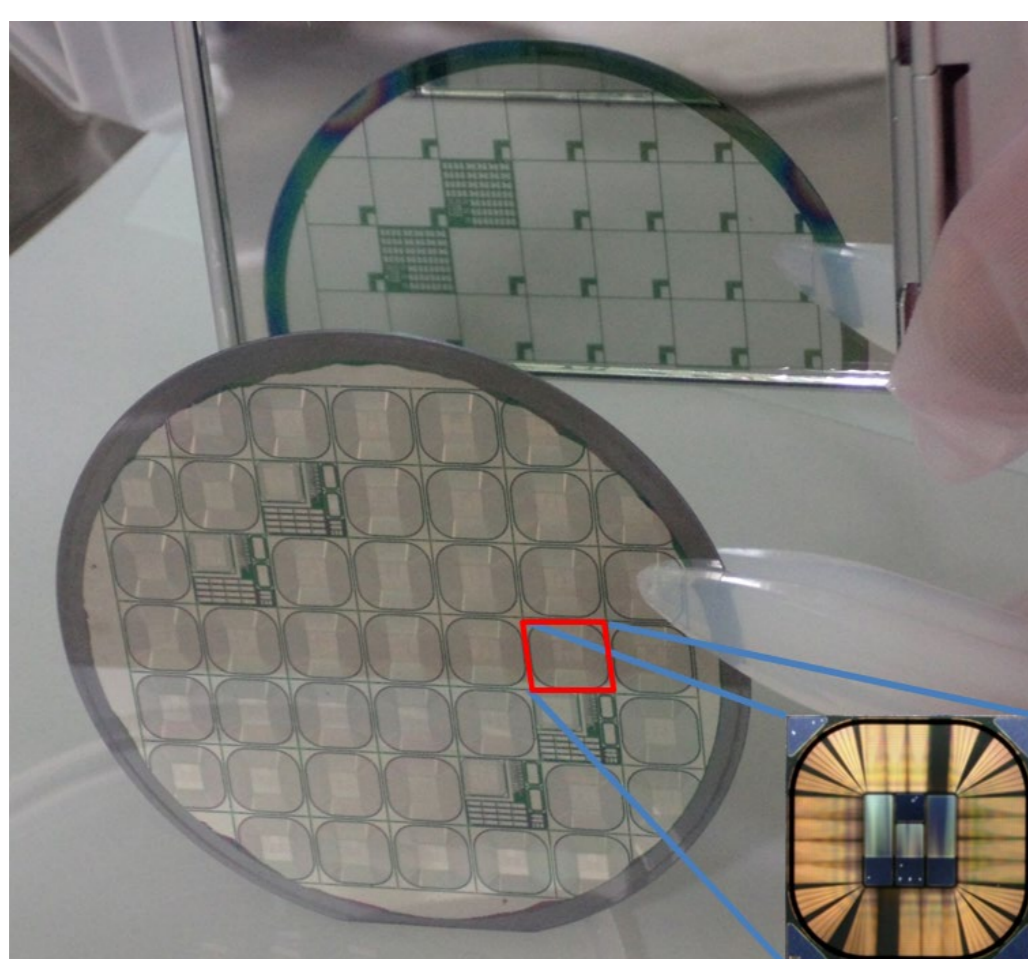

Fig. 2. The silicon power device project was initiated. The current density of IGBT was improved by the scaling concept at blocking voltage of 3000V. The double-gate IGBT was also demonstrated.

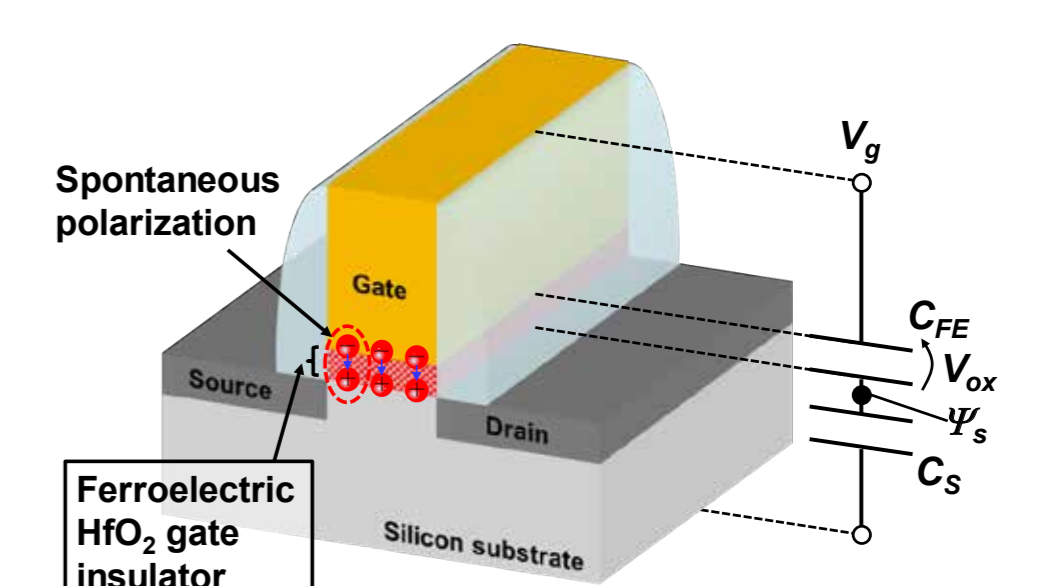
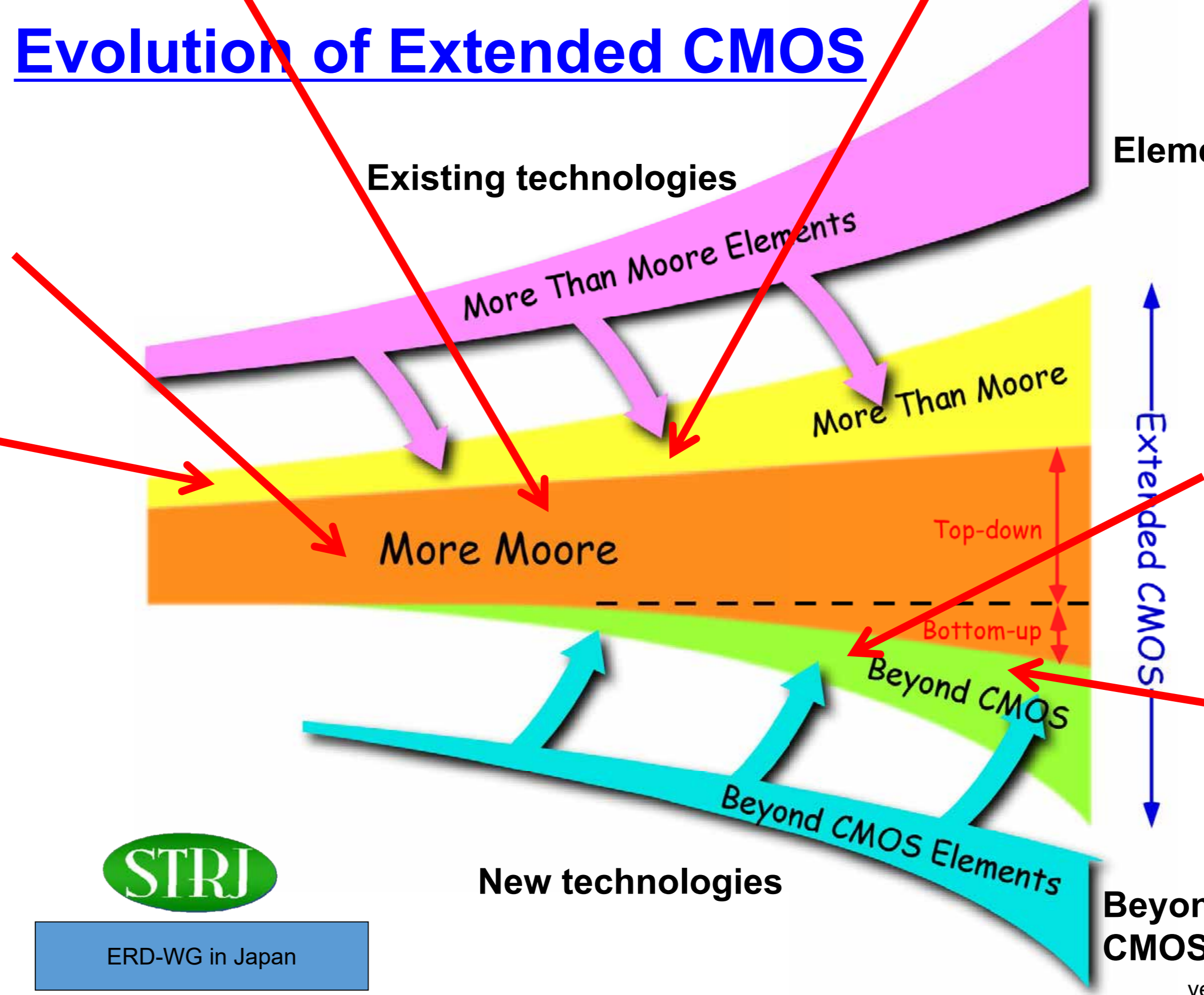

Fig. 6. Negative capacitance transistor can break the physical limit and achieve sub-60mV/dec steep subthreshold slope

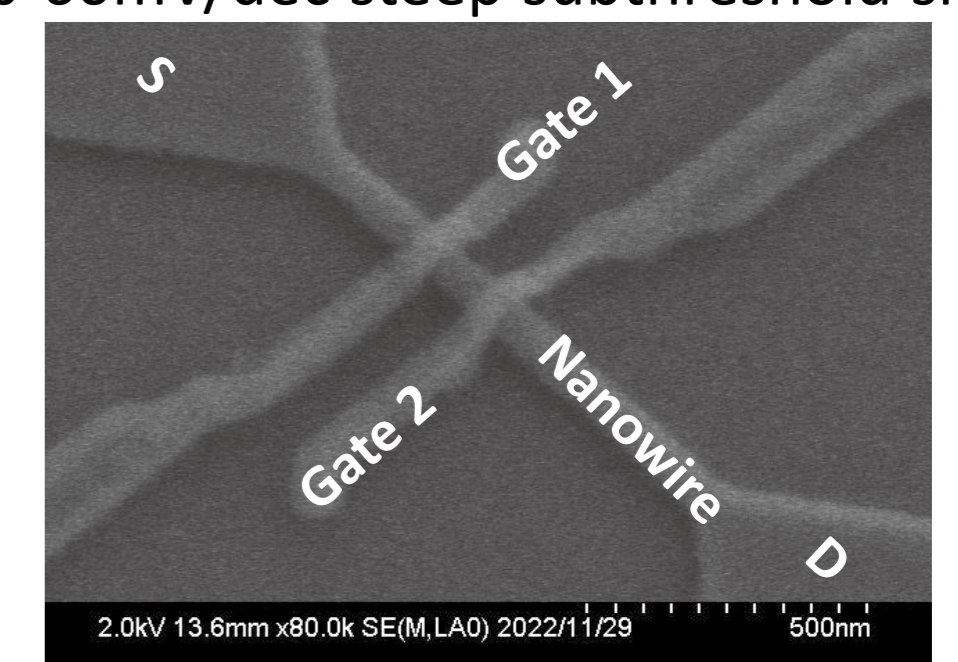

Fig. 7. A silicon quantum bit is promising for a key device element of quantum computing.

Fig. A. A vision map of the integrated nanoelectronics, drawn by Prof. Hiramoto in Semiconductor Technology Roadmap Committee of Japan (STRJ). A new field of "Extended CMOS" will be created by integrating "Beyond CMOS" and "More Than Moore" into CMOS base technology. This map is found in International Technology Roadmap for Semiconductor (ITRS).