

# AZIZ LAB.

## [Advanced Production and Utilization of Secondary Energy Sources Toward Energy Sustainability]

Department of Mechanical and Biofunctional Systems

Energy and Process Integration Engineering

Department of Mechanical Engineering

<http://epi.iis.u-tokyo.ac.jp>

A highly efficient and clean energy system is developed toward the realization of sustainable society. Analysis and modeling of micro to macro scale for each individual energy conversion process and elemental technology are performed, together with the effort to integrate them efficiently. In addition, a mutual correlation (conversion and utilization) between the electricity chemical energy is also studied.

### Highly efficient CO<sub>2</sub> free hydrogen production, storage and utilization

In order to realize the hydrogen society, highly efficient hydrogen production, storage and utilization systems are modeled and analyzed based on the concepts of exergy recovery and process integration. The hydrogen production employs chemical looping which is able to separate CO<sub>2</sub> and produce highly pure hydrogen.

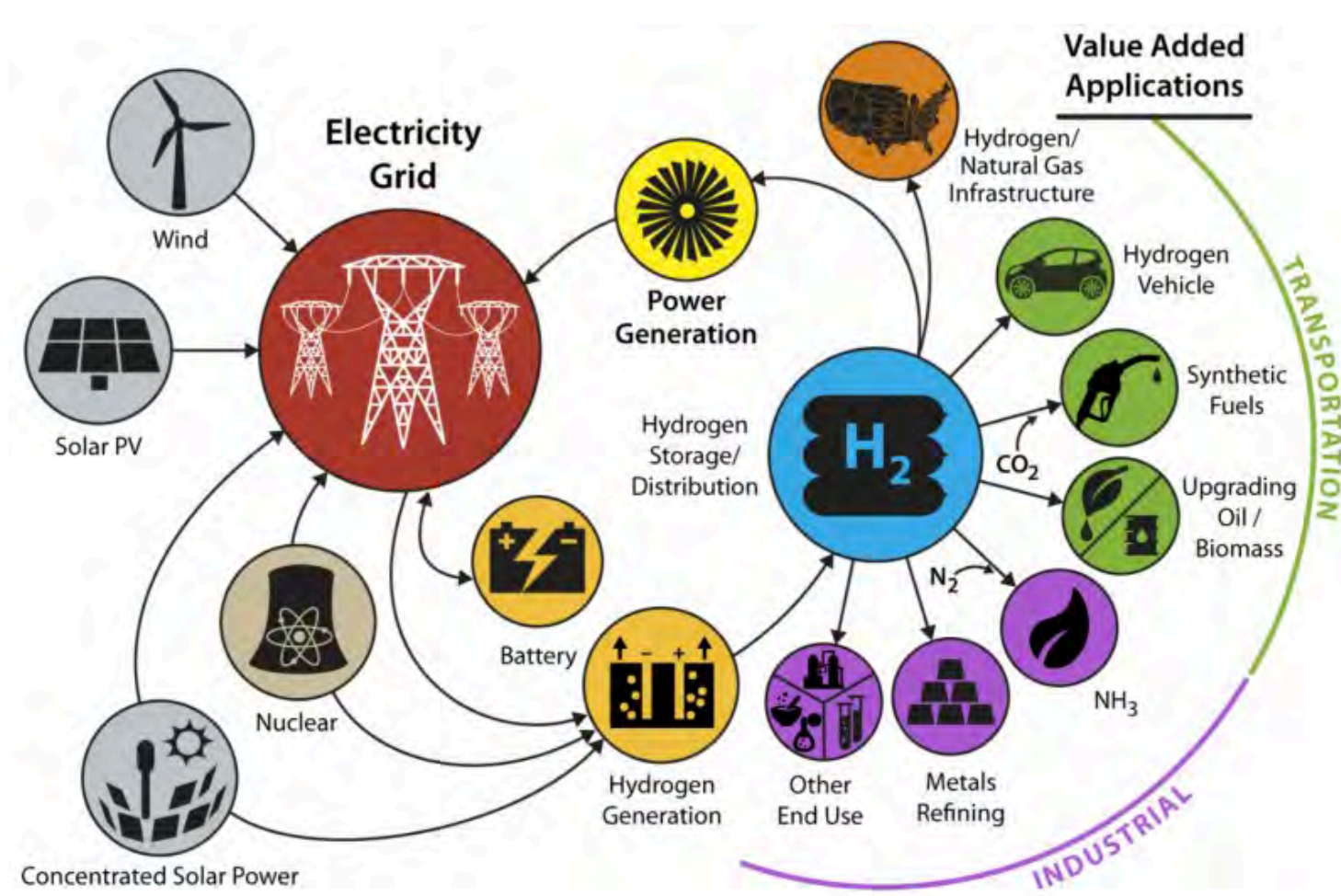

Mutual conversion and utilization of hydrogen and electricity

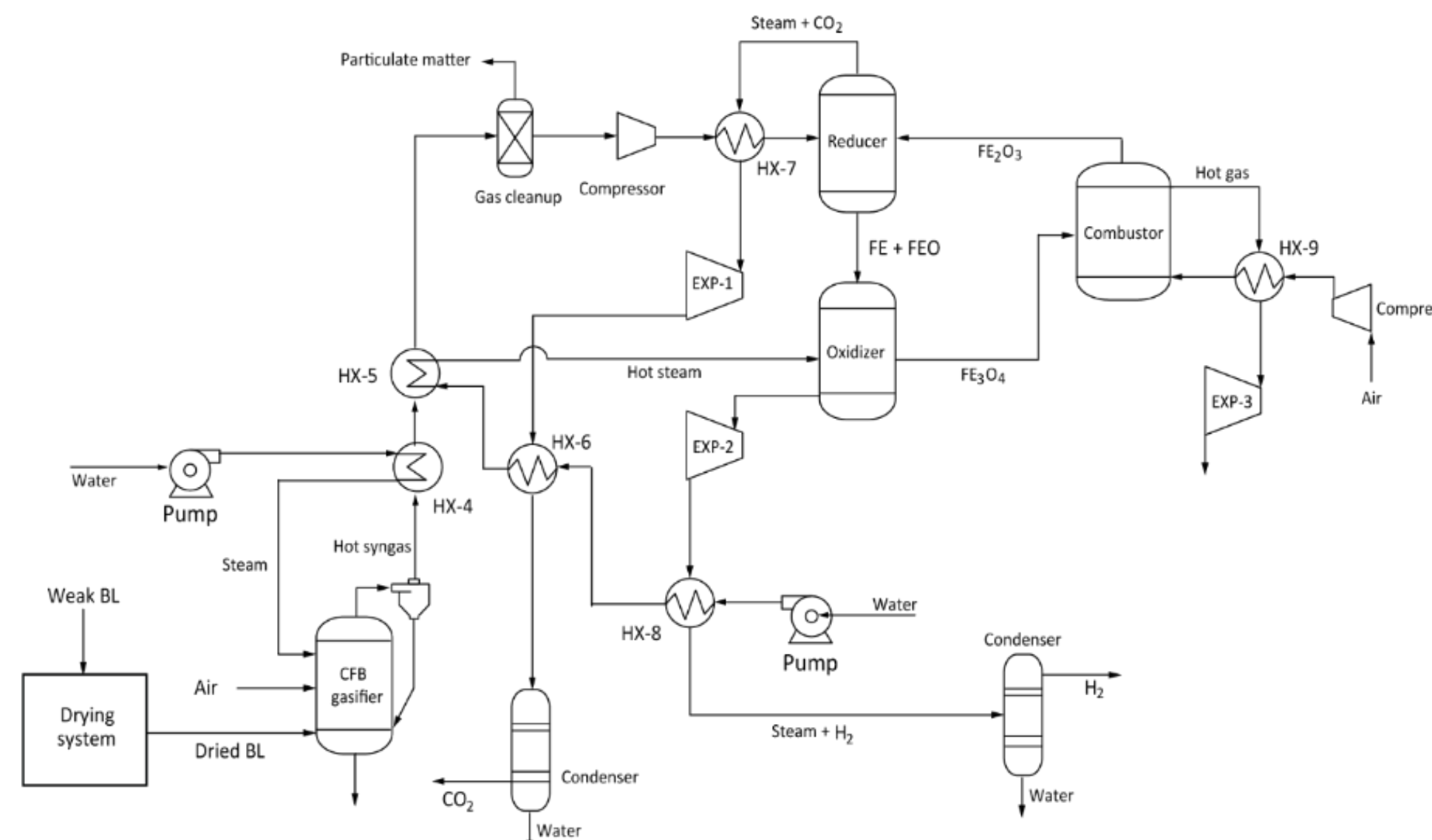

Highly efficient hydrogen production system utilizing industrial wastes

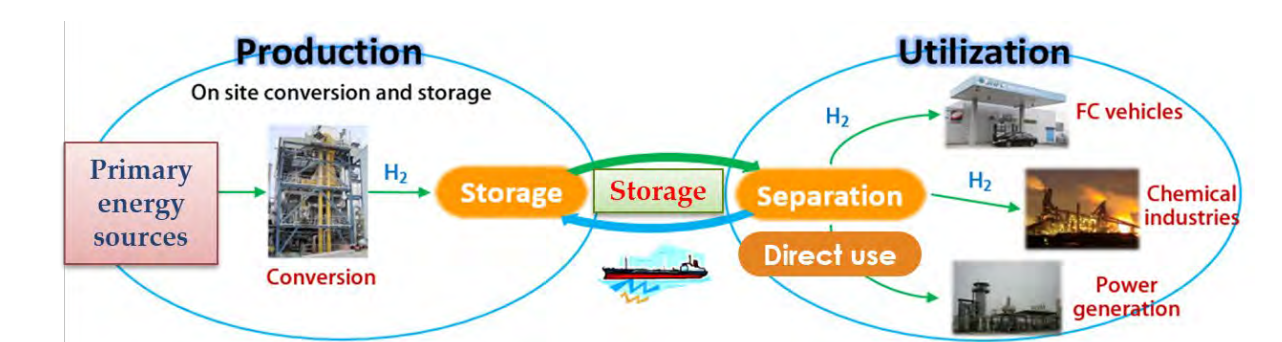

The concept of hydrogen production, storage, and utilization

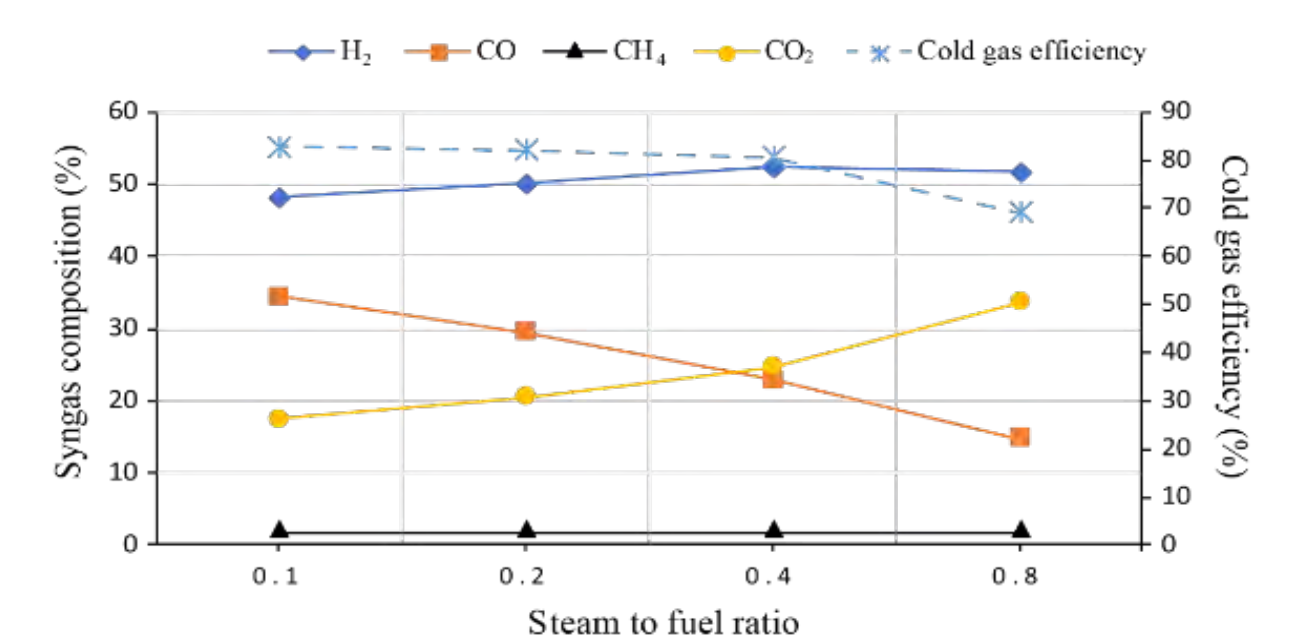

System performance

### Advanced Utilization of Electric Vehicles

The distributed electric vehicles (EVs) potentially provide ancillary services (e.g. frequency regulation) to the grid, especially when they are aggregated. The utilization of EVs results in a very responsive ancillary services compared to conventional regulators. In addition, an advanced utilization of reused battery from EVs is also studied in terms of its potential for energy storage, regulators, etc.

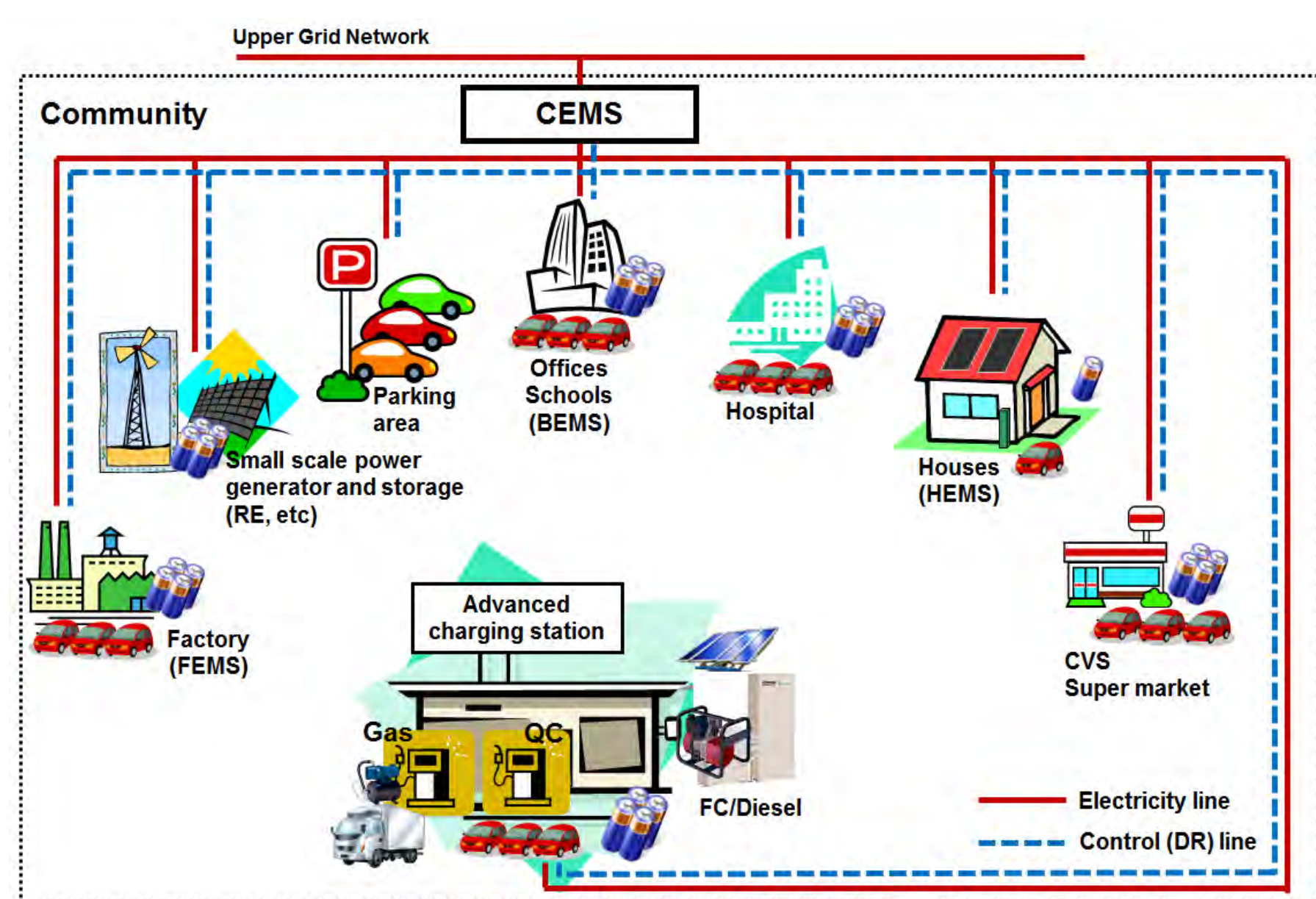

Vehicle-Grid-Integration (VGI)

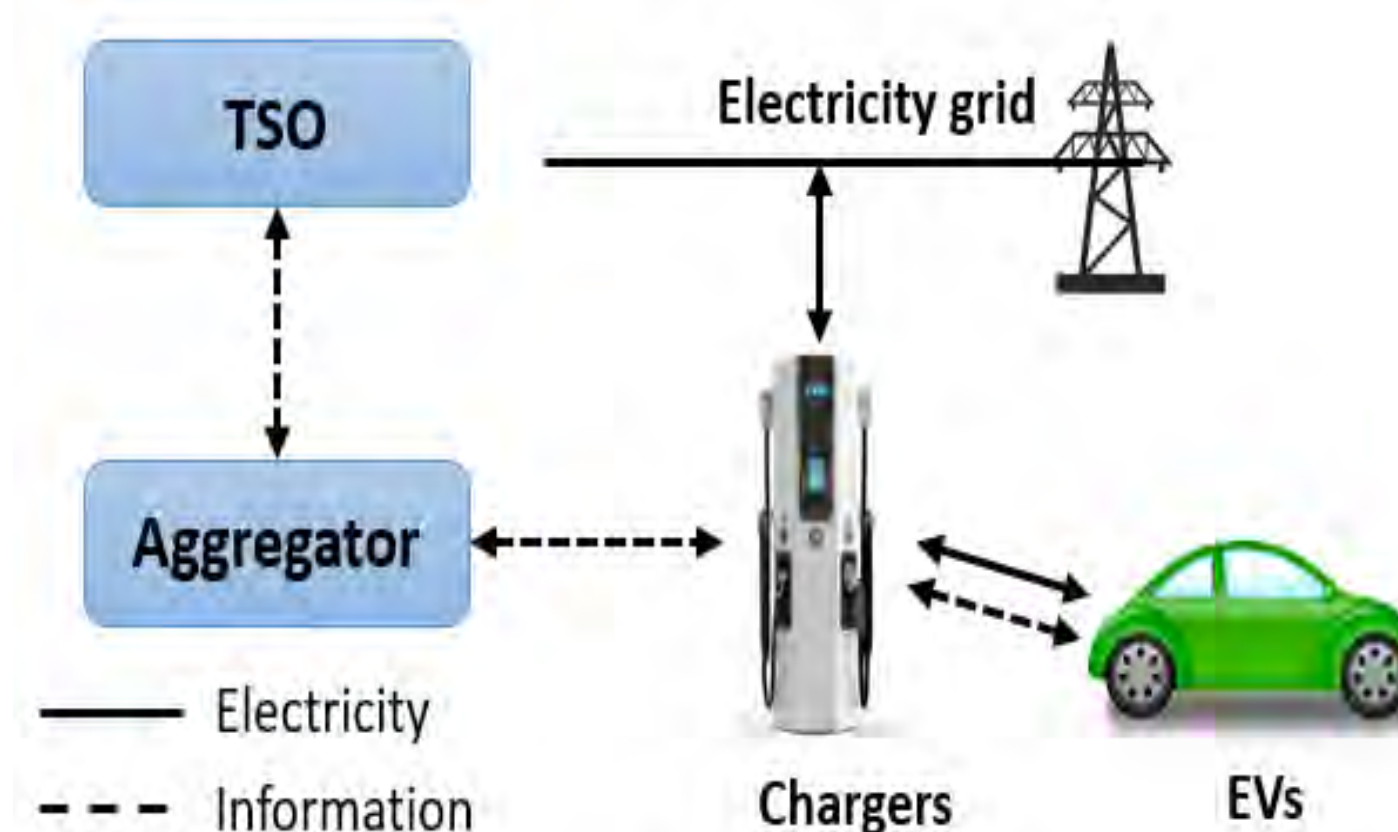

Basic configuration of VGI

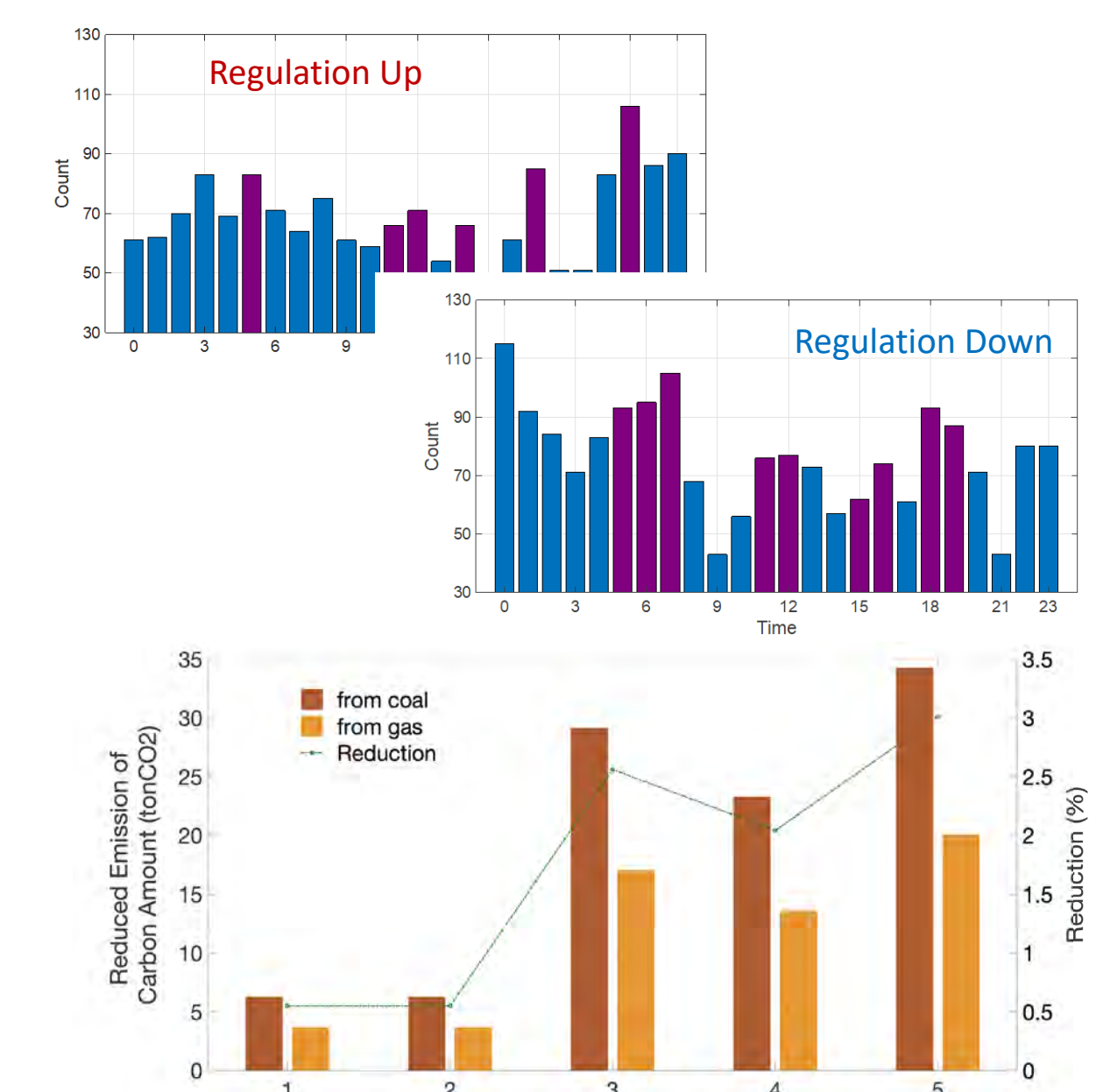

The effect of ancillary service in certain region